

After

SUPERATV.com

740B Clifty Drive • Madison, Indiana 47250 • 812-574-7777

LKK4 Brute Force 750 2" Lift Kit: 18 Installation Instructions

ITEM	DESCRIPTION	QTY.
A	Square Sway Bar Spacers	2
B	Front FWD Shock Mount Bracket	1
C	Front AFT Shock Mount Bracket	1
D	Rear FWD Shock Mount Bracket	1
E	Rear AFT Shock Mount Bracket	1
F	3/8"-16 x 2.25" Lg Hex Head Bolts	6
G	3/8"-16 x 2.50" Lg Hex Head Bolts	2
H	3/8" Flat Washers	8
I	3/8" Nylock Nuts	8
J	M8 x 40mm Lg Hex Head Bolts	4
K	M8 Flat Washers	4
L	M8 Nylock Nuts	4
M	1.25" Long Tube Spacers	2
N	1.0625" Long Tube Spacers	2

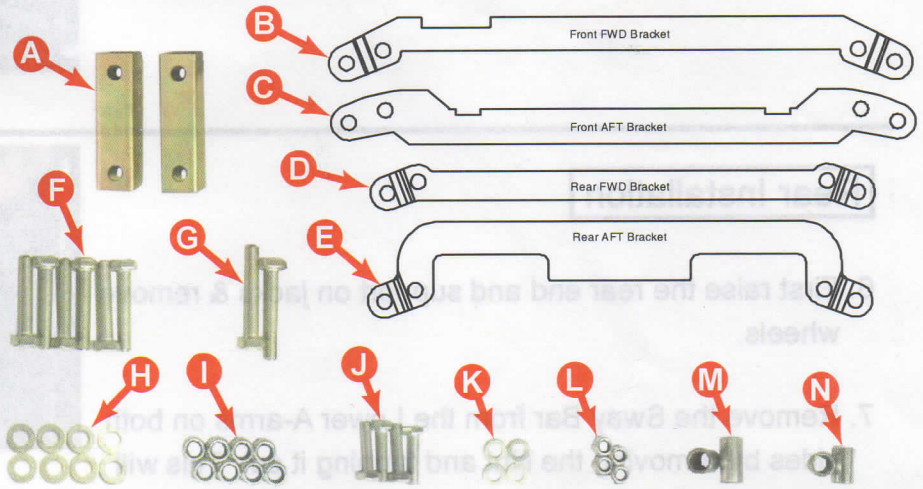

Front Installation

1. First raise the front end and support on jacks & remove wheels.
2. Now on one side, remove the Top shock bolt (see Fig.1) and pull the shock back out of the way.

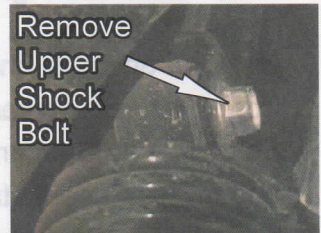

Fig.1

3. Locate the (2) Front Upper Shock Mount Brackets (items "B" & "C" above) provided in your kit. Now you will install them onto the factory frame. First, you will slide the **FWD** bracket plate (item "B") all the way thru from the side you are on to the other side, sliding it "in front" of the factory frame, or on the outside of the frame. Now, slide the **AFT** bracket plate all the way thru as you did the **FWD** plate, except this one goes "inside" the frame. Fig.2 shows this placement.

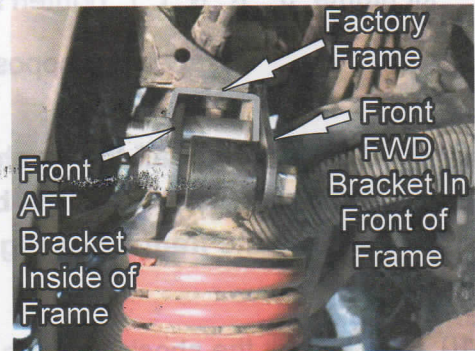

Fig.2

Front of Vehicle Direction →

4. Once the plates are in position, you will install them to the frame using the 3/8-16 x 2.25" Lg Hex Head Bolt, 1-1/16" Lg Tube Spacer, 3/8" Flat Washers & 3/8" Nylock Nut provided in your kit (items "F", "H", "N" & "I"). See Fig.3. Do Not Tighten until the shock has been installed in between the new shock mount bracket plates.

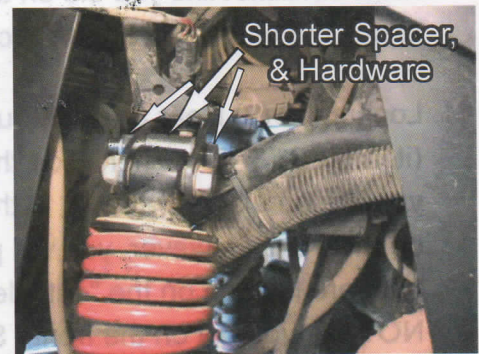

Fig.3

- Next, install the shock into the new Shock Mount Bracket plates using the 3/8-16 x 2.25" Lg Hex Head Bolt, 3/8" Flat Washers & 3/8" & NylockNut. See Fig.4.

After the shock is in place, now go back and tighten all hardware securely. Repeat previous steps for opposite side.

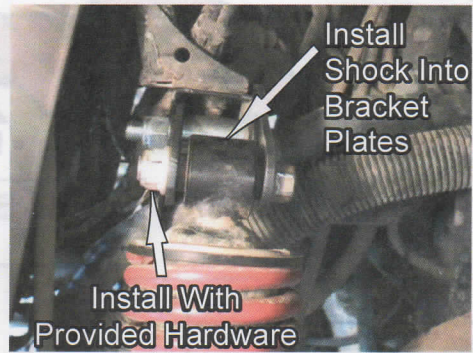

Fig.4

Rear Installation

- First raise the rear end and support on jacks & remove wheels.
- Remove the Sway Bar from the Lower A-arms on both sides by removing the Nut and tapping it out. This will allow the arms to lower which is needed for this installation. See Fig.5.

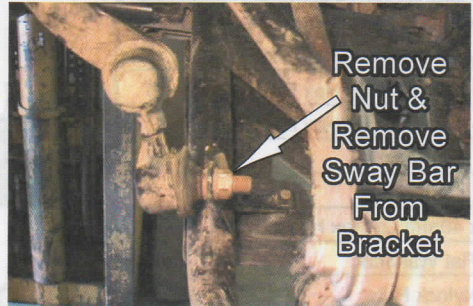

Fig.5

- Next, on one side only, unbolt the Sway Bar Mount from the frame, lower the Bar and insert one of the Square Tube Spacers (item "B") between the frame and the bar, and install using the M8 x 40mm Lg. Hex Head Bolts, Washers & Nylock Nuts provided in your kit (items "J", "K" & "L"). Tighten securely. See Fig.6 & 7.

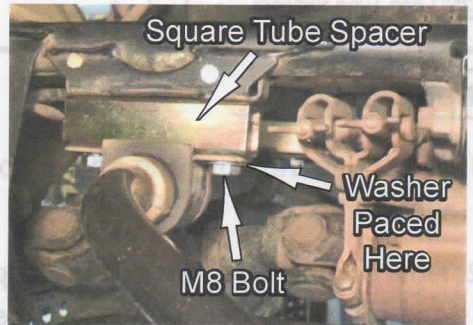

Fig.6

Repeat for opposite side.

NOTE: Be sure to install the washers between the bolt and Sway Bar so that the bolt will not bottom out into the frame. See Fig.7.

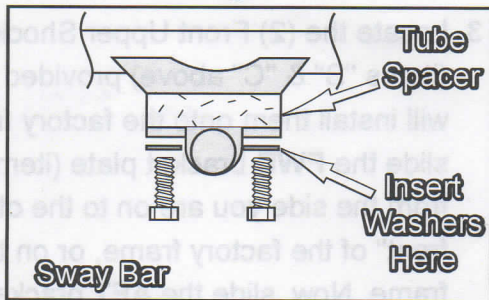

Fig.7

- Now, unbolt the shock from the Upper factory shock mount bracket like you did on the front, and pull the shock out of the bracket back out of the way.

- Locate the (2) Rear Shock Mount Bracket plates (items: "D" & "E"). Then slide them thru from the side you are on all the way thru to the other side as you did on the front. However, you will position them so they both are located on the "outside" of the factory frame NOT like you did on the front. See Fig.8.

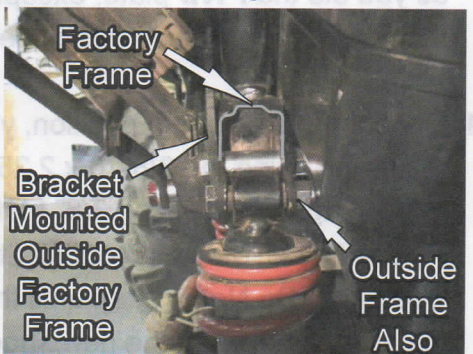

Fig.8

12. Now you will install the plates onto the factory frame. Do this by using the 3/8"-16 x 2-1/2" Lg Hex Head Bolt, Washers, 1-1/4" Lg Tube Spacer and Nylock Nut provided in your Kit (items: "G", "H" "I" & "M"). The Spacer goes inside the factory frame running the bolt thru it. Be sure to keep loose until the shock has been installed between the new Bracket plates. See Fig.9.

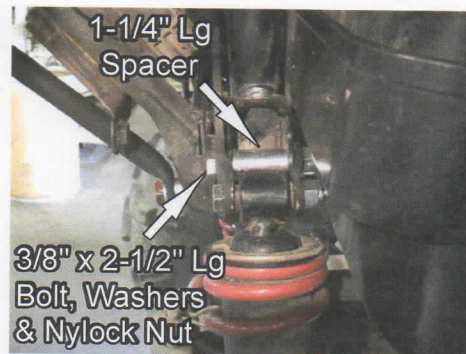

Fig.9

13. Once the Brackets are in place, next install the shock into the new Shock Mount Bracket plates. Do this by using the 3/8"-16 x 2-1/4" Lg Hex Head Bolt, Washers & Nylock Nut provided in your kit (items: "F", "H" & "I"). See Fig.10.

After the shock is in place, now go back and tighten all hardware securely. Repeat previous steps for opposite side.

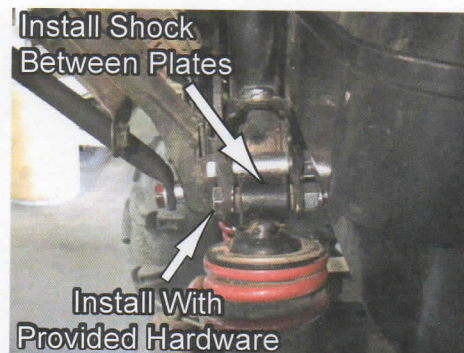

Fig.10

13. After both sides have been installed, now go back and reinstall the Sway Bar back onto both Lower A-arms and tighten securely.

You're Ready To Ride!

*Thank You
For Choosing*

SUPERATV.com